

### TOP VIEW

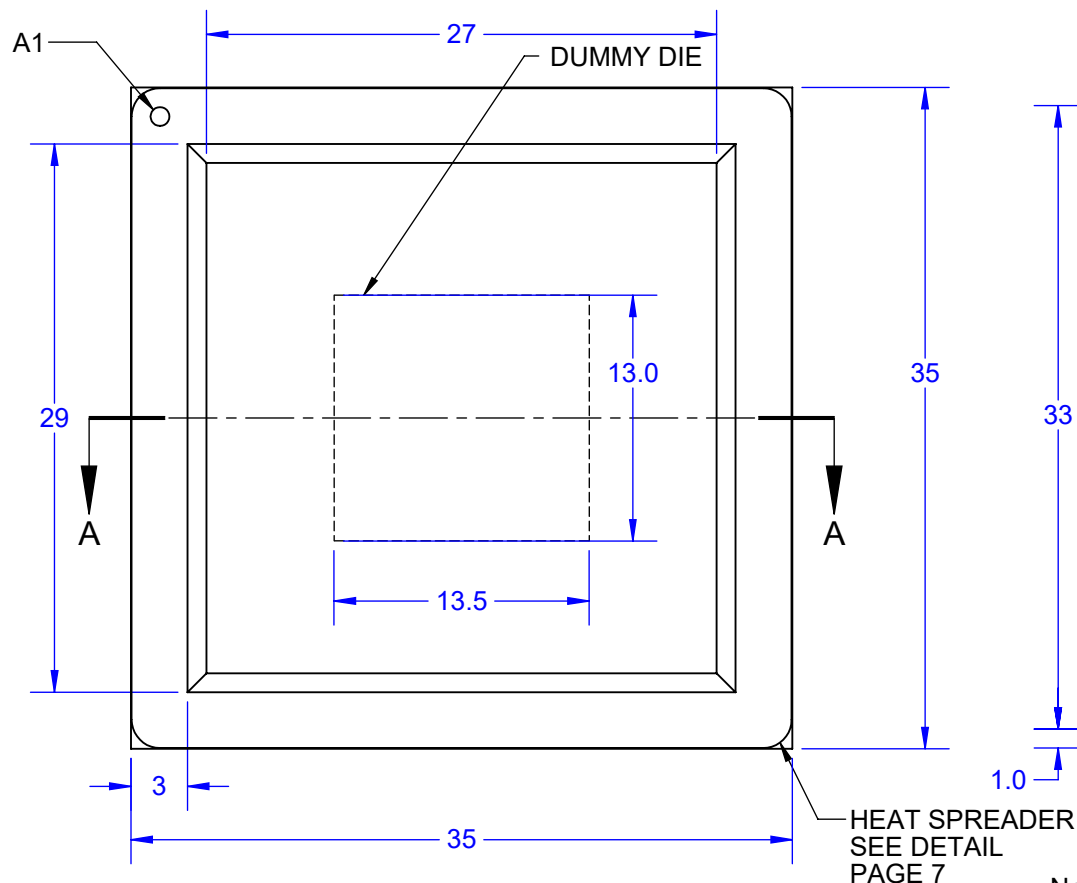

### BALL VIEW

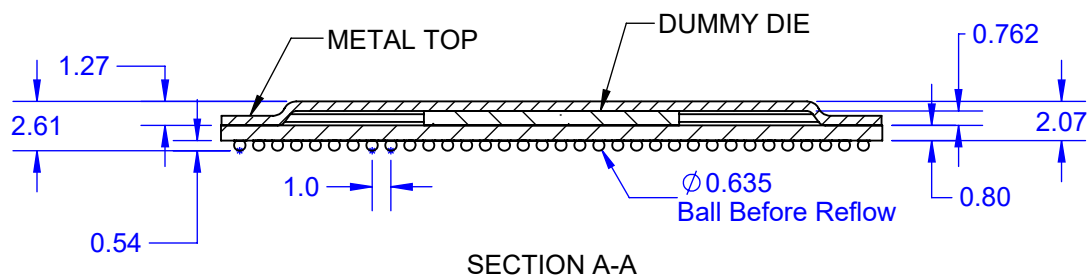
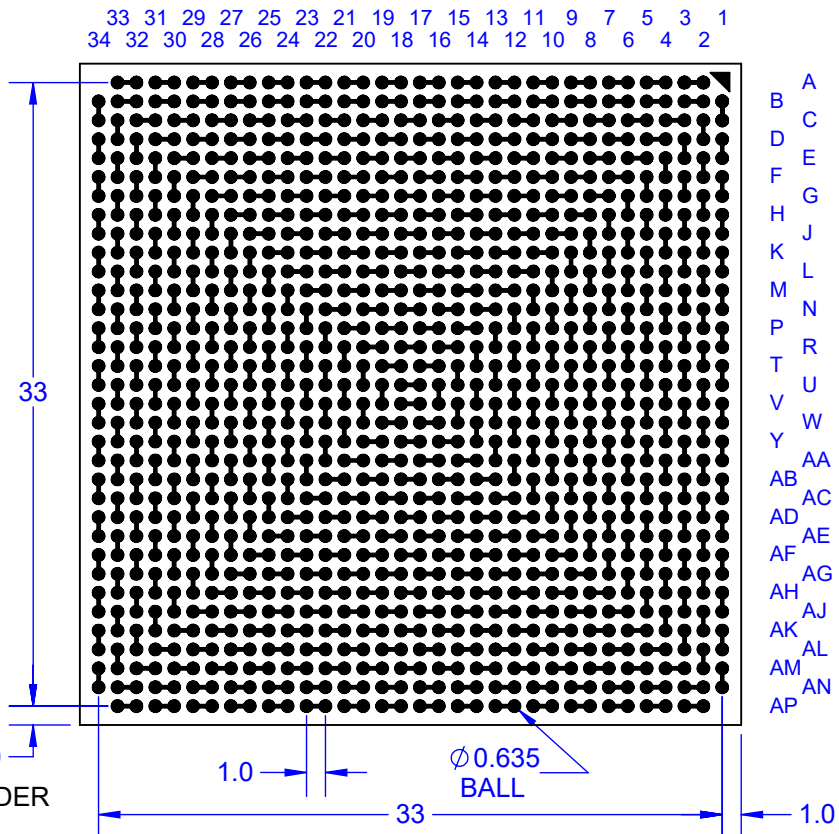

Notes: (Unless Otherwise Specified).

- 1) ALL DIMENSIONS ARE IN MM.
- 2) SOLDER BALL ALLOY: SEE PART NUMBER TABLE.
- 3) BALL DIAMETER (BEFORE REFLOW) 0.635mm [25 mil].
- 4) SOLDER MASK DEFINED PAD OPENING: 0.508mm [20mil].
- 5) PAD Cu DIAMETER: 0.635mm [25 mil].
- 6) SUBSTRATE MATERIAL: FR4 (OPTIONAL BT).
- 7) DUMMY DIE: Si (SILICON).
- 8) DAISY CHAIN PATTERN (SEE PAGE 2).
- 9) MSL-3 RECOMMENDED BAKING 24 HOURS @ 125°C TO REMOVE MOISTURE PRIOR TO SOLDERING TO PC BOARD.

#### PART NUMBER TABLE

PART NUMBER	BALL METAL	BALL ALLOY	RoHS	Si DIE
SBGA1152T1.0C-DC349D	Sn96.5/Ag3.0/Cu0.5	SAC305	YES	YES
SBGA1152T1.0-DC349D	Sn63/Pb37	Sn63	NO	YES

APPROVALS	DATE	<b>TopLine®</b>					
DRAWN T. Au	8/20/2021						
ENG M. Hart	8/20/2021	TITLE SBGA1152T1.0-DC349D DAISY CHAIN DUMMY		SCALE	SIZE	DRAWING NO.	REV
MFG				2.5:1	A	513445	B
QA		DO NOT SCALE DRAWING		SHEET 1 OF 9			
CUST							
REVISED							

## BALL VIEW

33 31 29 27 25 23 21 19 17 15 13 11 9 7 5 3 1  
34 32 30 28 26 24 22 20 18 16 14 12 10 8 6 4 2

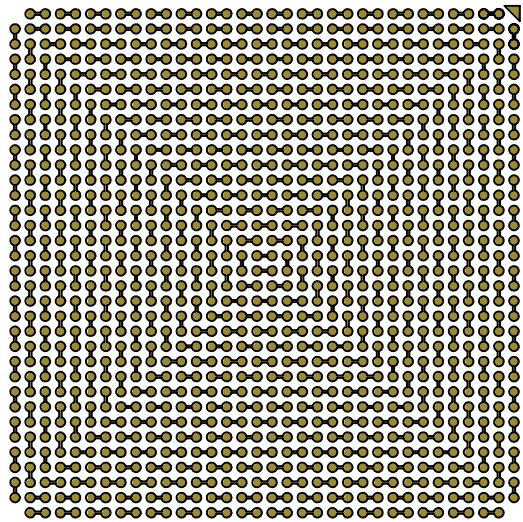

A  
B C  
D E  
F G  
H J  
K L  
M N  
P R  
T U  
V W  
Y AA  
AB AC  
AD AE  
AF AG  
AH AJ  
AK AL  
AM AN  
AP

## BOTTOM SIDE (TOP X-RAY VIEW)

2 4 6 8 10 12 14 16 18 20 22 24 26 28 30 32 34  
1 3 5 7 9 11 13 15 17 19 21 23 25 27 29 31 33

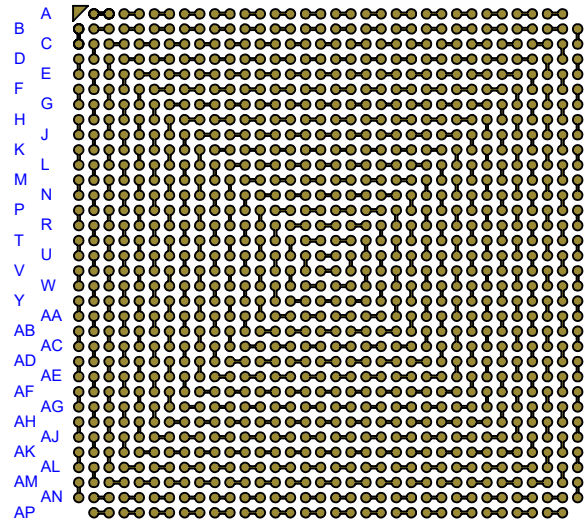

A  
B C  
D E  
F G  
H J  
K L  
M N  
P R  
T U  
V W  
Y AA  
AB AC  
AD AE  
AF AG  
AH AJ  
AK AL  
AM AN  
AP

T+ T-

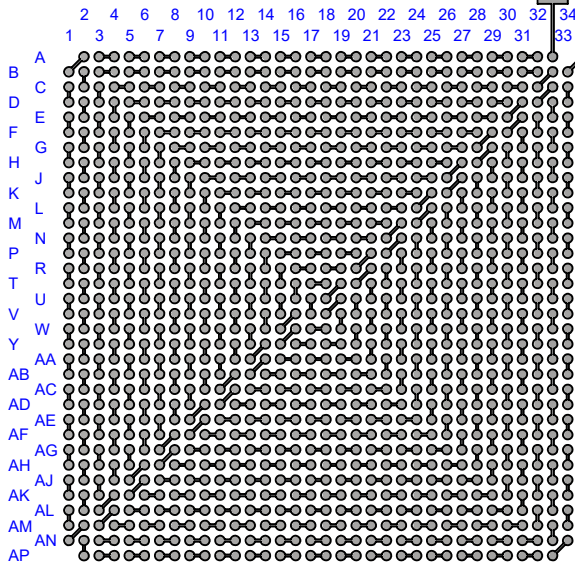

A  
B C  
D E  
F G  
H J  
K L  
M N  
P R  
T U  
V W  
Y AA  
AB AC  
AD AE  
AF AG  
AH AJ  
AK AL  
AM AN  
AP

## TEST VEHICLE BOARD

T+ T-

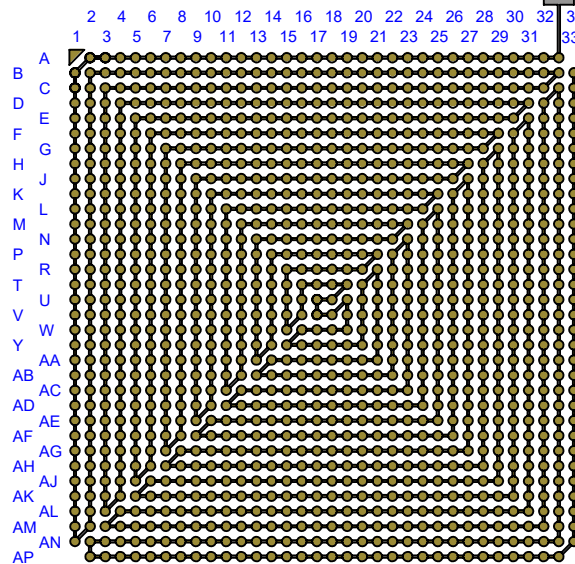

A  
B C  
D E  
F G  
H J  
K L  
M N  
P R  
T U  
V W  
Y AA  
AB AC  
AD AE  
AF AG  
AH AJ  
AK AL  
AM AN  
AP

## AFTER MOUNTING

Notes: (Unless Otherwise Specified).

- 1) PCB BOARD DIMENSIONS ARE PRESENTED ONLY AS A GUIDELINE DESIGNERS SHOULD USE THEIR OWN KNOWLEDGE WHEN DESIGNING THE PCB.
- 2) PCB Cu BALL PAD DIAMETER: 0.450 [25 mil].
- 3) PCB DAISY CHAIN TRACING LINE WIDTH: 0.152 [6mil].
- 4) SMD (SOLDERMASK DEFINED) PAD OPENING: 0.508mm [20mil].

**TopLine**<sup>®</sup>

TITLE SBGA1152T1.0-DC349D  
DAISY CHAIN DUMMY

SCALE	SIZE	DRAWING NO.	REV
2:1	A	513445	B

DO NOT SCALE DRAWING

SHEET 2 OF 9

# BALL VIEW

34 33 32 31 30 29 28 27 26 25 24 23 22 21 20 19 18 17 16 15 14 13 12 11 10 9 8 7 6 5 4 3 2 1

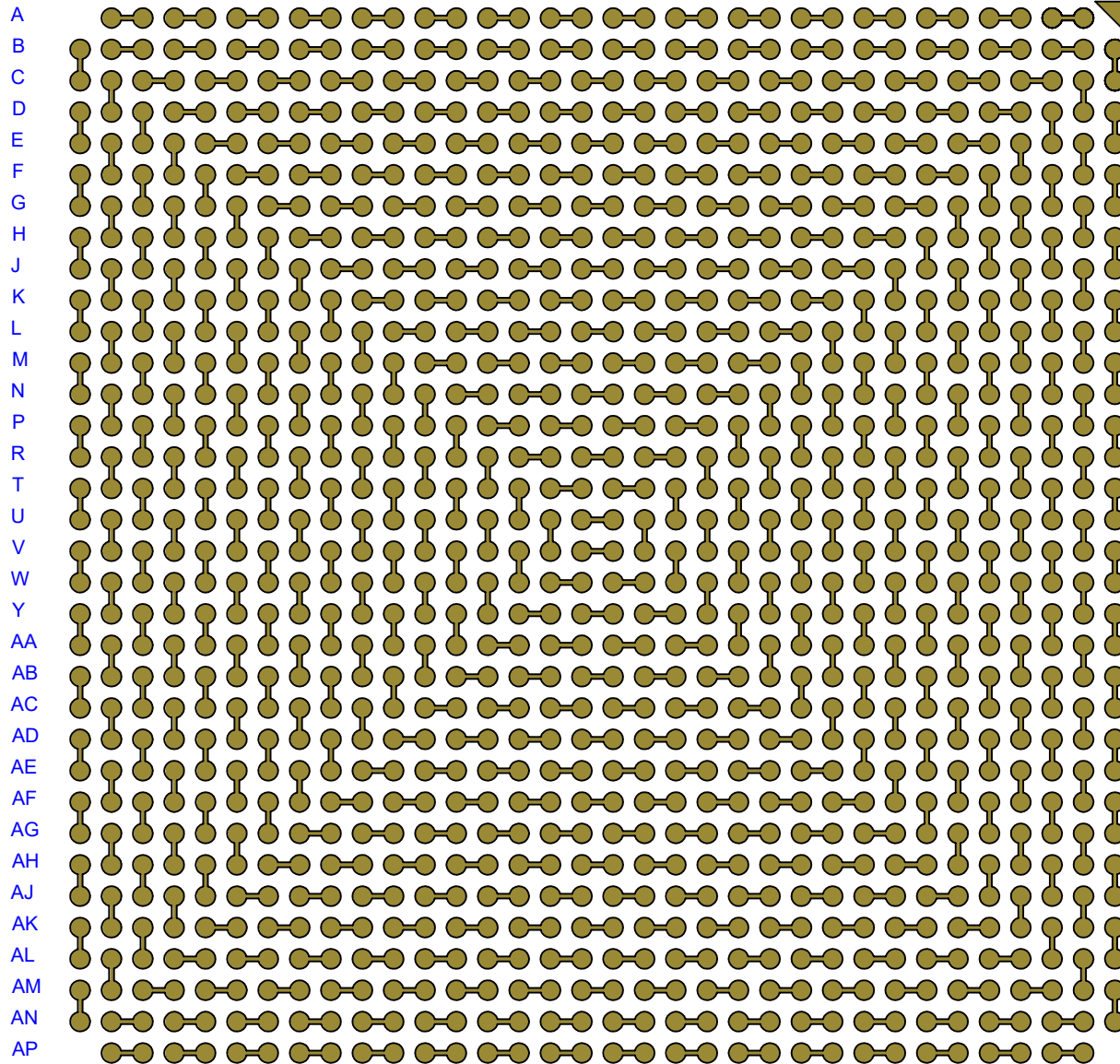

<b>TopLine®</b>			
TITLE		SBGA1152T1.0-DC349D DAISY CHAIN DUMMY	
SCALE	SIZE	DRAWING NO.	REV
4.5:1	A	513445	B
DO NOT SCALE DRAWING			SHEET 3 OF 9

# BOTTOM SIDE (TOP X-RAY VIEW)

1 2 3 4 5 6 7 8 9 10 11 12 13 14 15 16 17 18 19 20 21 22 23 24 25 26 27 28 29 30 31 32 33 34

A  
B  
C  
D  
E  
F  
G  
H  
J  
K  
L  
M  
N  
P  
R  
T  
U  
V  
W  
Y  
AA  
AB  
AC  
AD  
AE  
AF  
AG  
AH  
AJ  
AK  
AL  
AM  
AN  
AP

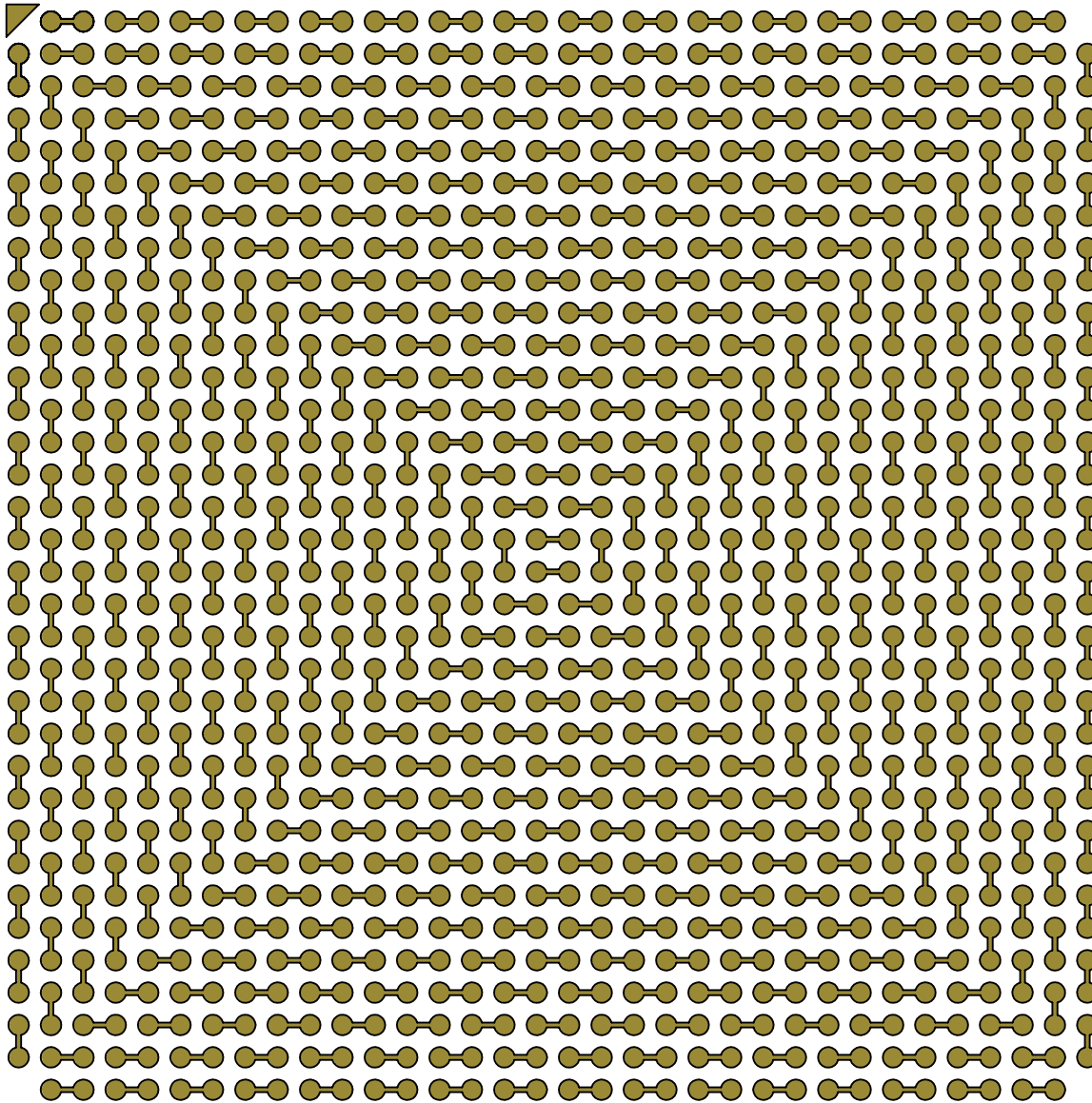

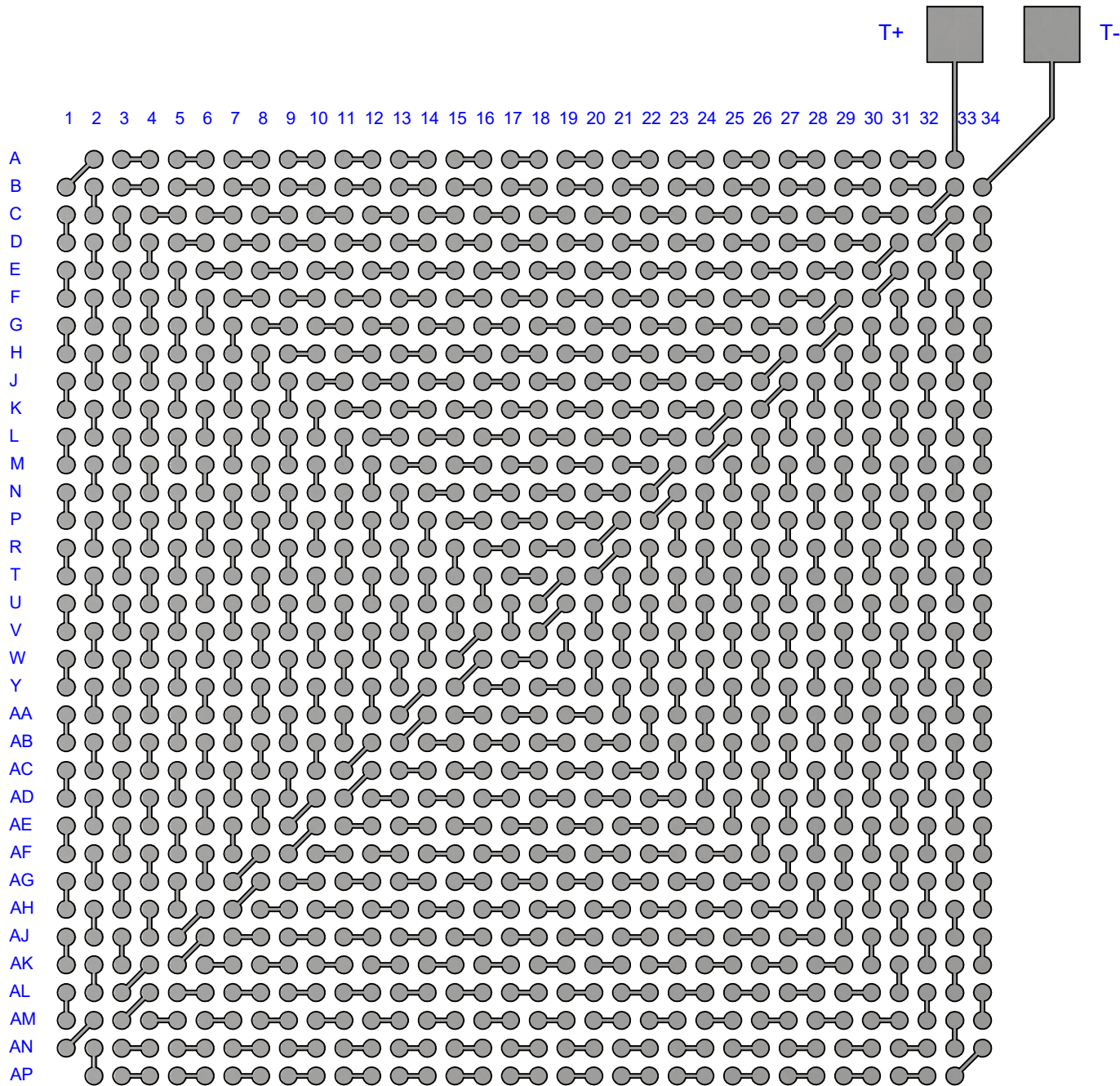

<b>TopLine®</b>			
TITLE		SBGA1152T1.0-DC349D DAISY CHAIN DUMMY	
SCALE	SIZE	DRAWING NO.	REV
4.5:1	A	513445	B
DO NOT SCALE DRAWING			SHEET 4 OF 9

# TEST VEHICLE BOARD



<b>TopLine®</b>			
TITLE		SBGA1152T1.0-DC349D DAISY CHAIN DUMMY	
SCALE	SIZE	DRAWING NO.	REV
4.5:1	A	513445	B
DO NOT SCALE DRAWING			SHEET 5 OF 9

# AFTER MOUNTING TO TEST BOARD

T+   T-

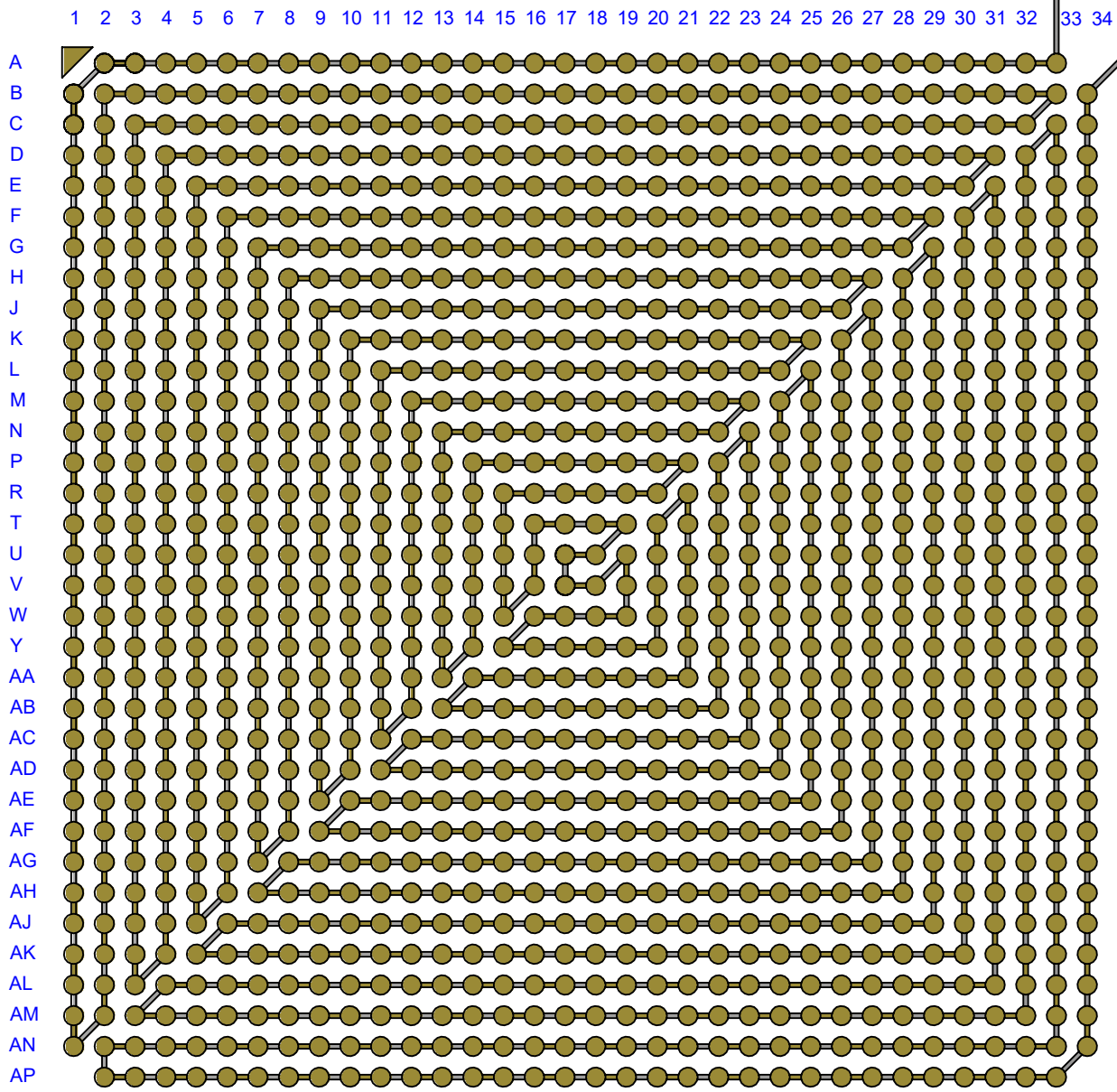

<b>TopLine<sup>®</sup></b>			
TITLE    SBGA1152T1.0-DC349D DAISY CHAIN DUMMY			
SCALE	SIZE	DRAWING NO.	REV
4.5:1	A	513445	B
DO NOT SCALE DRAWING			SHEET 6 OF 9

# HEAT SPREADER

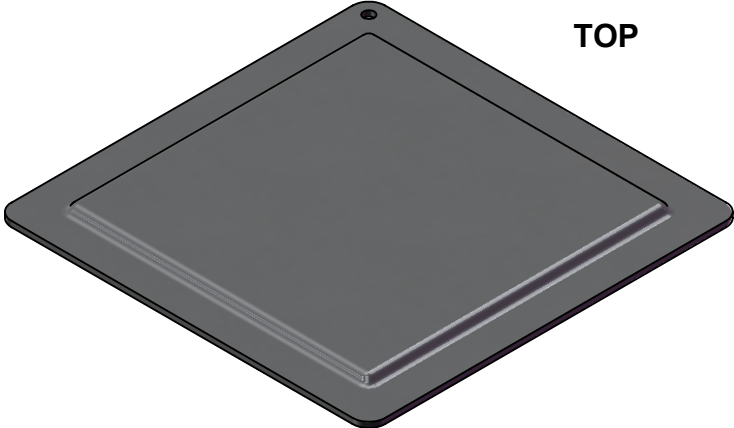
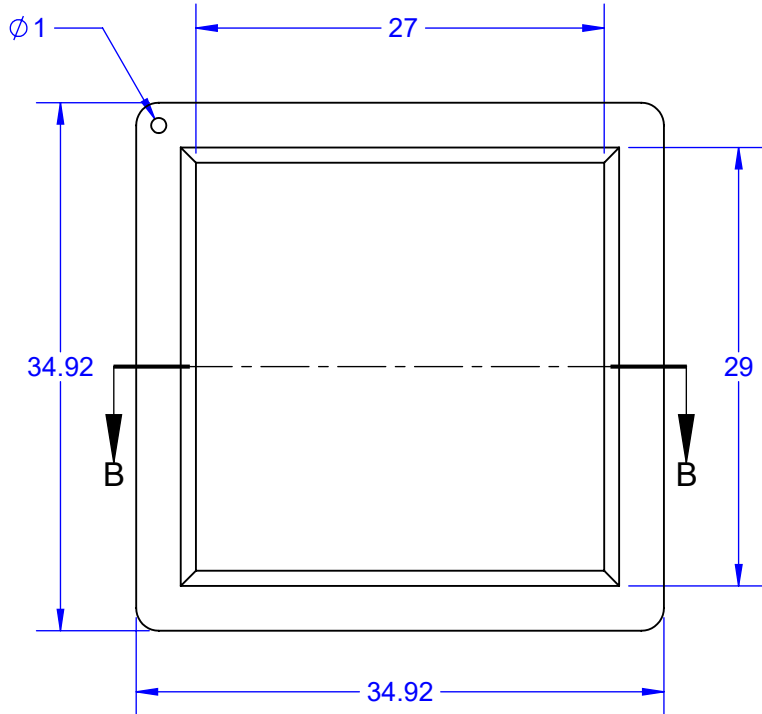

TOP

MODEL

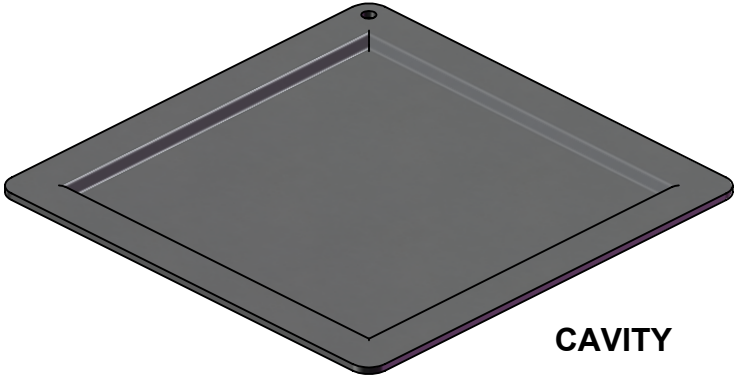

CAVITY

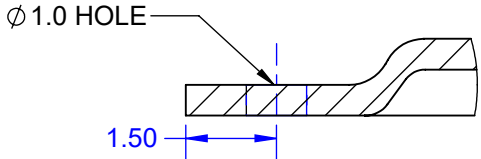

DETAIL E  
SCALE 8 : 1

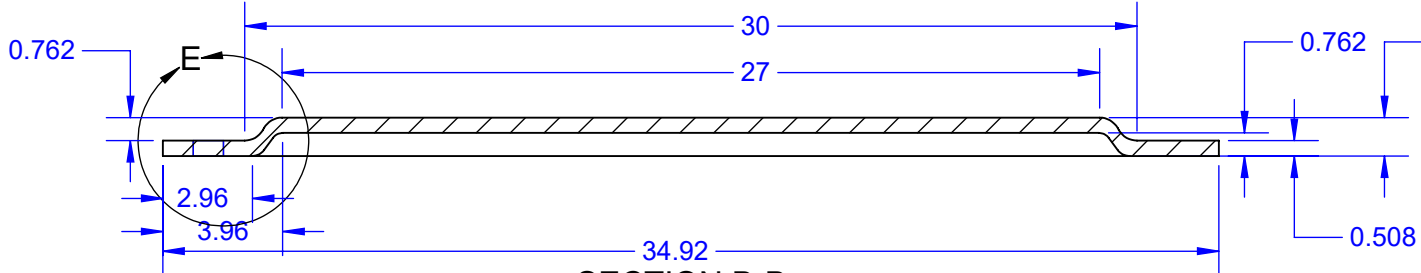

SECTION B-B  
SCALE 4 : 1

\* ADD 0.13MM SEALANT

<b>TopLine®</b>			
TITLE SBGA1152T1.0-DC349D DAISY CHAIN DUMMY			
SCALE 2:1	SIZE A	DRAWING NO. 513445	REV B
DO NOT SCALE DRAWING			SHEET 7 OF 9

# MODEL

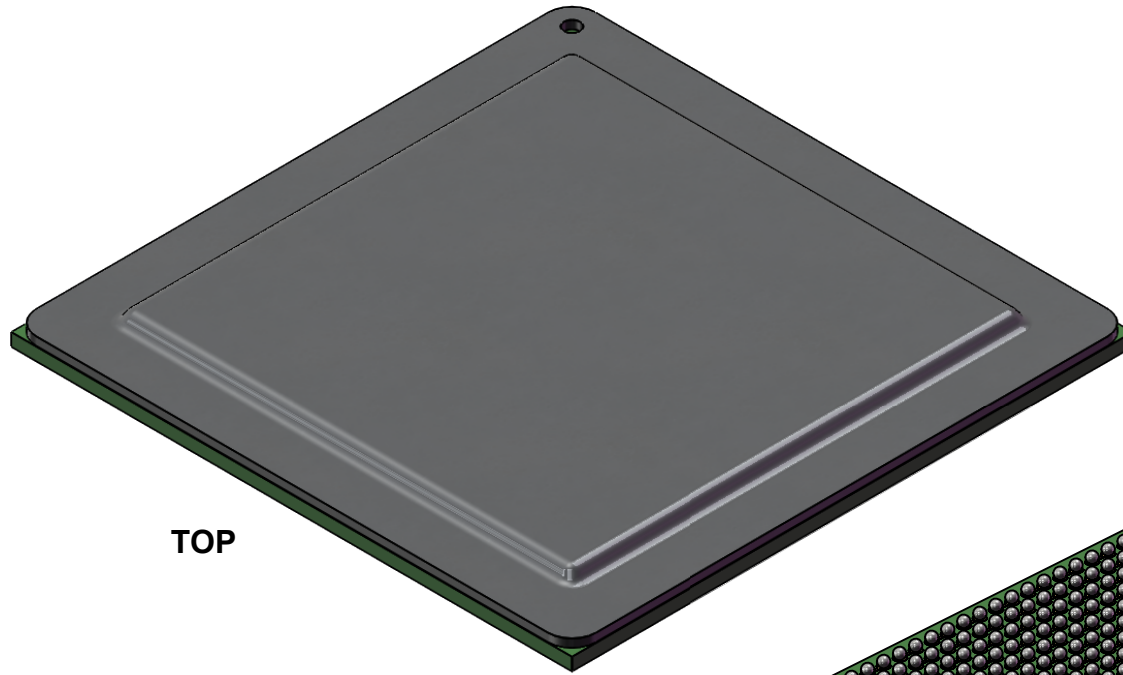

TOP

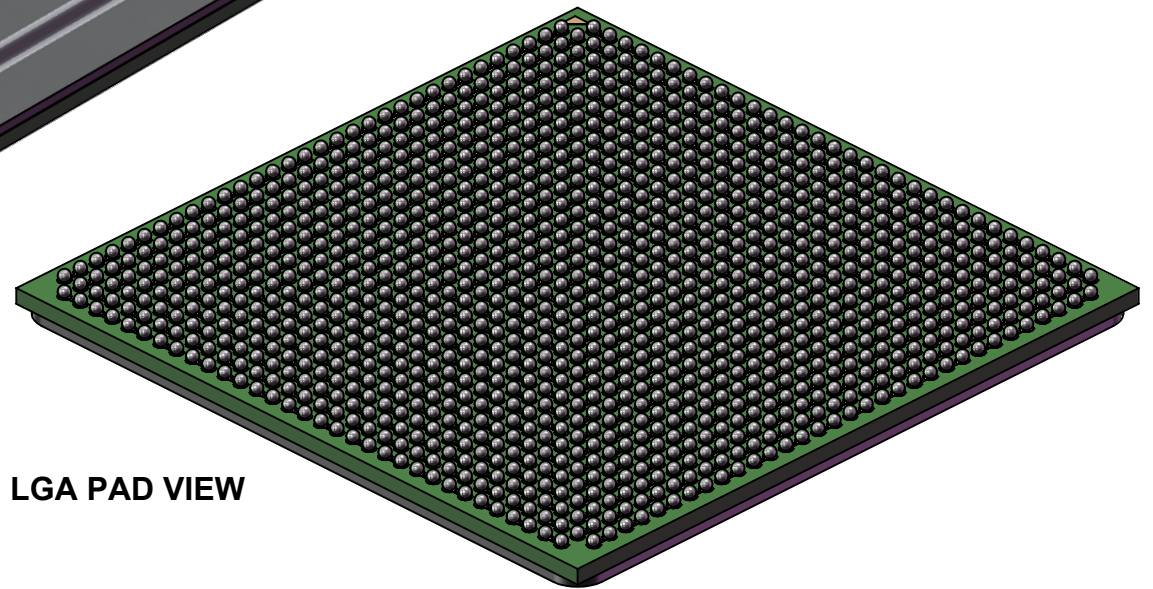

LGA PAD VIEW

**TopLine**<sup>®</sup>

TITLE SBGA1152T1.0-DC349D  
DAISY CHAIN DUMMY

SCALE	SIZE	DRAWING NO.	REV
3:1	A	513445	B

DO NOT SCALE DRAWING

SHEET 8 OF 9



# BOTTOM SOLDER MASK (RIGHT READING)

34 33 32 31 30 29 28 27 26 25 24 23 22 21 20 19 18 17 16 15 14 13 12 11 10 9 8 7 6 5 4 3 2 1

A  
B  
C  
D  
E  
F  
G  
H  
J  
K  
L  
M  
N  
P  
R  
T  
U  
V  
W  
Y  
AA  
AB  
AC  
AD  
AE  
AF  
AG  
AH  
AJ  
AK  
AL  
AM  
AN  
AP

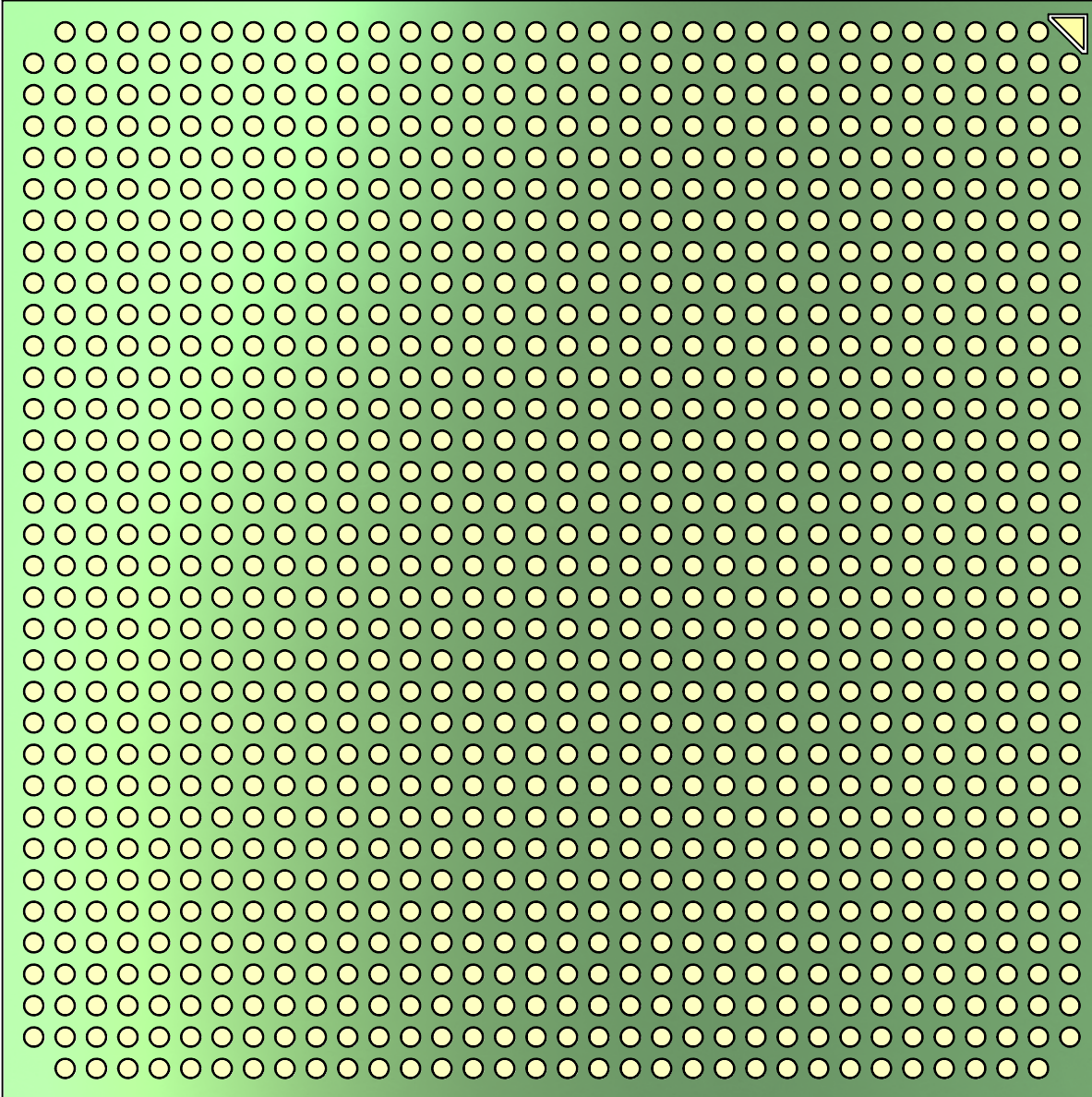

<b>TopLine®</b>			
TITLE    SBGA1152T1.0-DC349D DAISY CHAIN DUMMY			
SCALE	SIZE	DRAWING NO.	REV
4.5:1	A	513445	B
DO NOT SCALE DRAWING			SHEET 9 OF 9